

FRONT VIEW

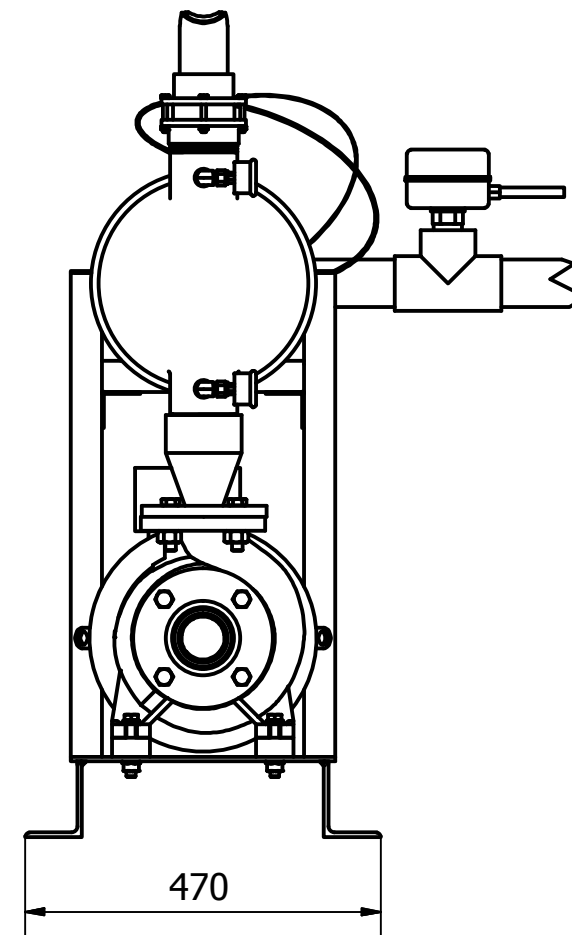

SIDE VIEW

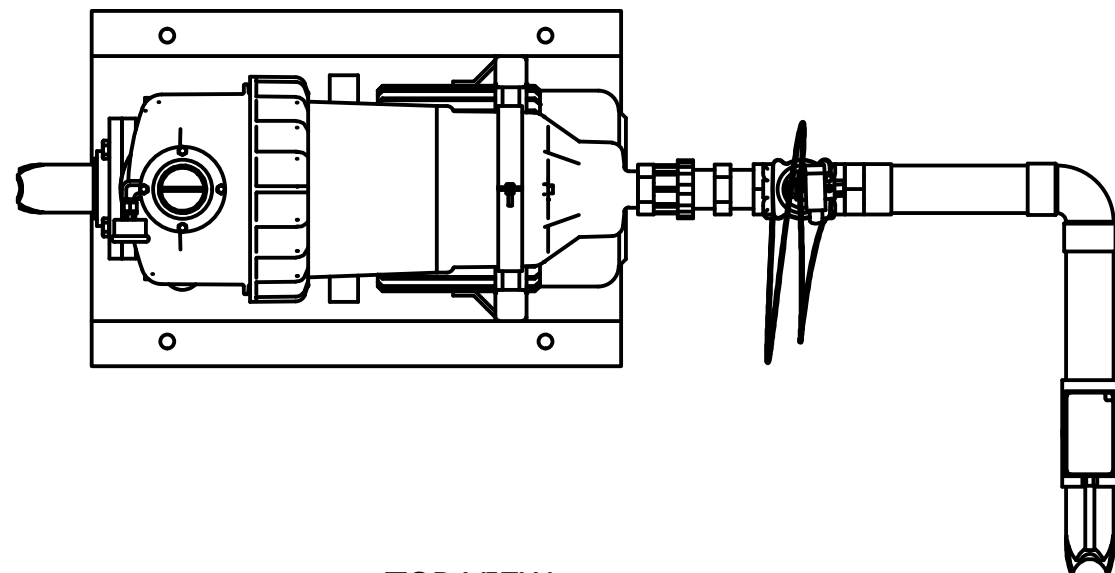

TOP VIEW

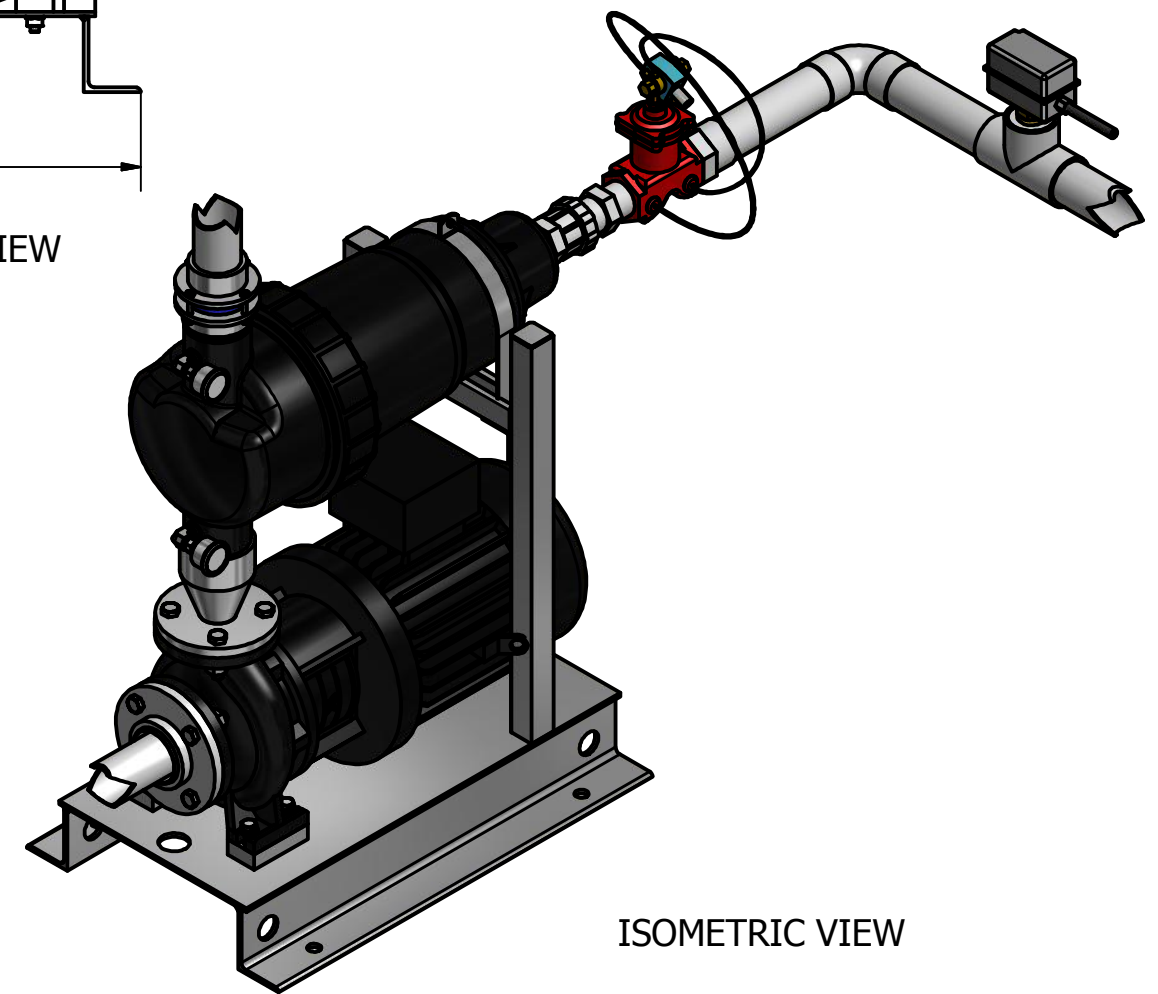

ISOMETRIC VIEW

Designed by SAM	Checked by	Approved by	Date	Date 23-May-14	
			V-200_7.5KW		
			Edition	Sheet 1 / 1	