



FILTRATION SYSTEMS



General Information

Consider a separator's use where any source of water contains contaminants with a weight of 2.6 specific gravity or higher, such as well water to remove sand. Separators are also excellent for use as a pre-removal device for filters with river or ditch water that contain high levels of sand or other large organic debris.

Applications would include, but not be limited to: wells, industrial processes, water recycling and reuse, river and ditch water intake systems, food processing nozzle systems and irrigation water.

How It Works

Liquids and solids enter the unit and begin travelling in a circular flow. This centrifugal action forces heavier particles downward in a spiral motion to the separation chamber. The particles collect in this separation chamber and are purged from the system. The filtered water is drawn to the separator's vortex and up through the outlet.

Hydrocyclone Separators

VAF Hydrocyclone Separators are effective in removing suspended particles from any flow stream of water where the specific gravity (density) of the particle(s) is heavier than the fluid it is in; the more significant the difference in gravity between the water and the particle, the greater the efficiency of the removal process. Depending on the specific gravity of the particle and the viscosity of the flow stream, very small and denser particles can be removed.

NOTE: Particulate removal can be enhanced if multiple passes of the stream can be achieved.

Advantages

- No moving parts
- Removal of 98% solids 2.6 specific gravity and higher at maximum flow rate (see back side)
- Heavy duty, corrosion resistant construction for a long service life
- No electricity required
- Capacities of 1 to 1,771 m³/hr (4 to 7,800 gpm)
- Simple installation
- Excellent pre-removal to reduce load on downstream filtration components
- Low cost
- Made in the USA
- Custom skids available

VAF Filtration Systems

5270 Marshall Street, Arvada, CO 80002 USA
Phone +1 303 425 4242 Fax +1 303 425 0112
www.vafusa.com
sales@vafusa.com

Particulate Removal Efficiencies

Based on Specific Gravity and Flow Rate

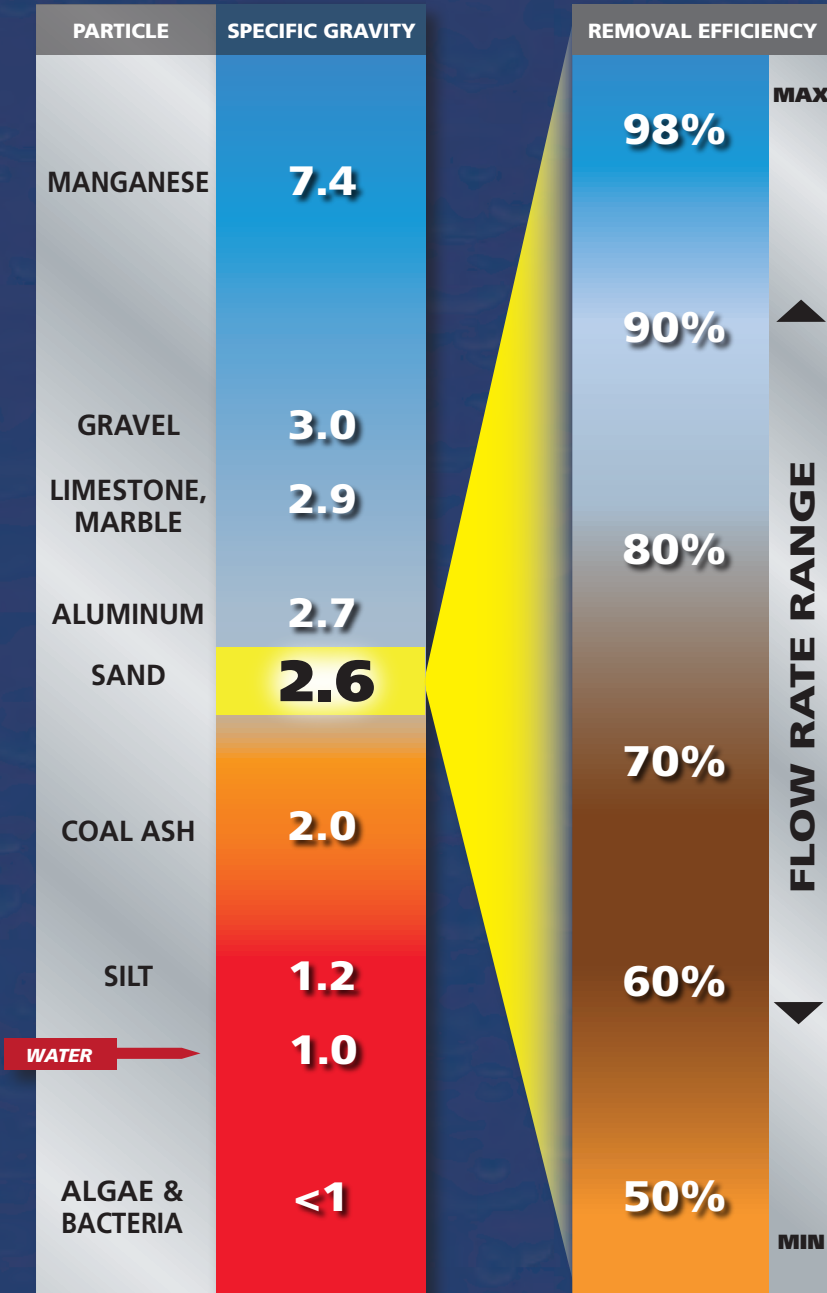

Specific Gravity

The more significant the difference between the specific gravity (density) of the particle and the water it is in, the greater the efficiency of the removal process of the particle.

Removal Efficiency

The efficiency of the separation process is reduced based on the percentage reduction from the maximum stated flow of each model – see model flow rate chart above.

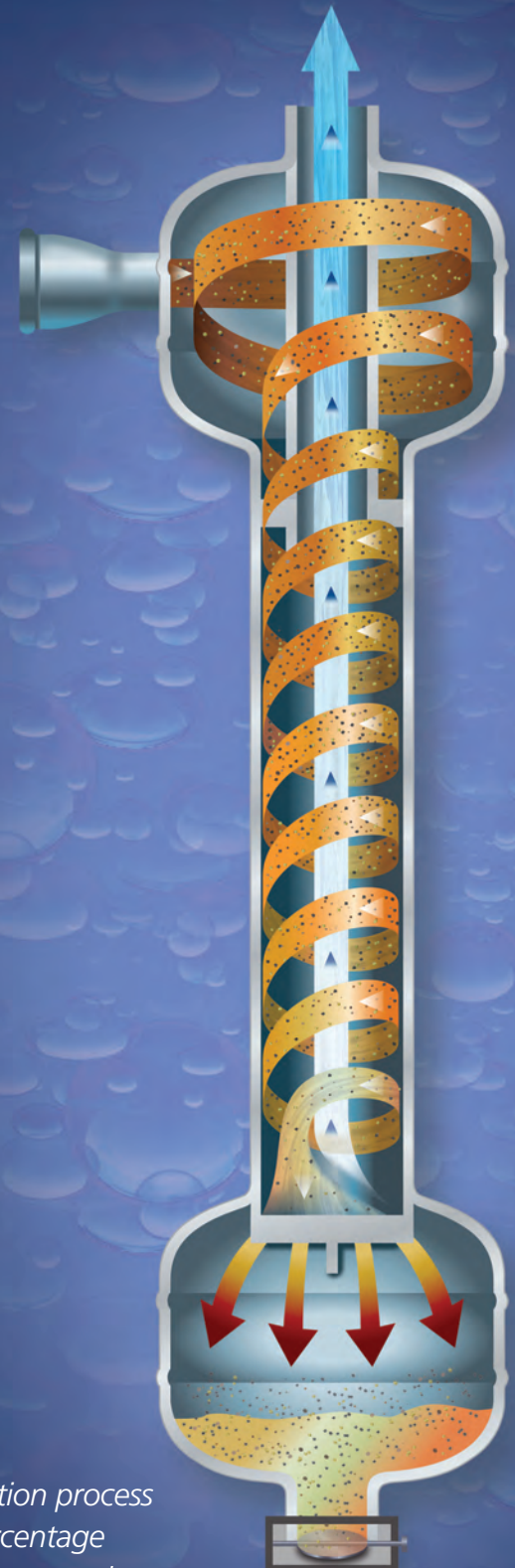

Separator Specifications

To select the optimal separator, match your flow rate to the listed flow range. Operating below the specified flow range will result in low efficiency. Operating above the specified flow range will impose unnecessary pressure drop across the separator.

**Unless otherwise noted, ALL models are installed vertically.
Operating Pressure: 1.5 bar to 10 bar (25 psi to 150 psi)**

MODEL	FLOW		LINE SIZE		LENGTH		WEIGHT		FLUSH SIZE	
	gpm	m ³ /hr	in	cm	in	cm	lb	kg	in	cm
VHS-10	4 - 10	1 - 2	0.5	1.3	20	50.8	13	6	1	2.54
VHS-20	10 - 20	2 - 5	0.75	1.9	20	50.8	15	7		
VHS-40	18 - 38	4 - 9	1.0	2.5	30.5	77.5	26	12		
VHS-50	26 - 52	6 - 12	1.25	3.2	30.5	77.5	26	12		
VHS-80	38 - 79	9 - 18	1.5	3.8	30.5	77.5	26	12		
VHS-120	63 - 120	15 - 28	2.0	5.1	36	91.4	44	20	2	5.08
VHS-180	100 - 180	23 - 41	2.5	6.4	44	111.8	55	25		
VHS-260	125 - 260	29 - 60	3.0	7.6	48	121.9	75	34		
VHS-340	190 - 345	44 - 79	4.0	10.2	52	132.1	120	55		
VHS-400A	200 - 400	46 - 92	4	10.2	80	203.2	280	127	2	5.08
VHS-700A-LF	365 - 700	84 - 161	6	15.2	106.25	269.9	493	224		
VHS-950A-HF	500 - 950	115 - 219	6	15.2	106.25	269.9	493	224		
VHS-1600A	800 - 1600	184 - 369	8	20.3	114	289.6	722	328		
VHS-2300A	1300 - 2300	299 - 529	10	25.4	139	353.1	840	382		
VHS-3400A	2025 - 3400	465 - 782	12	30.5	139	353.1	1400	636		
VHS-5000A	2975 - 5000	684 - 1150	14	35.6	152.5	387.4	2000	907		
VHS-6200A	4000 - 6200	920 - 1426	16	40.6	160	406.4	2310	1048		
VHS-7800A	5000 - 7800	1135 - 1771	18	45.7	177	449.6	2750	1248		

Standard construction material is Carbon Steel. Stainless Steel is available upon request.

Automatic-Purge Timer Controller & Motorized Ball Valve

PVB-1LT-120 1" Auto-Purge Timer

PVB-2LT-120 2" Auto-Purge Timer

Auto-Purge Timer includes 120 VAC controller with LCD display with push button controls and brass ball valve.

Other options, voltages and materials available.

Notes:

VHS = VAF Hydrocyclone Separator

A = Mounted at 22.5 degree angle. Supplied with support legs.

LF = Low Flow

HF = High Flow

Angled Separator Dimensions

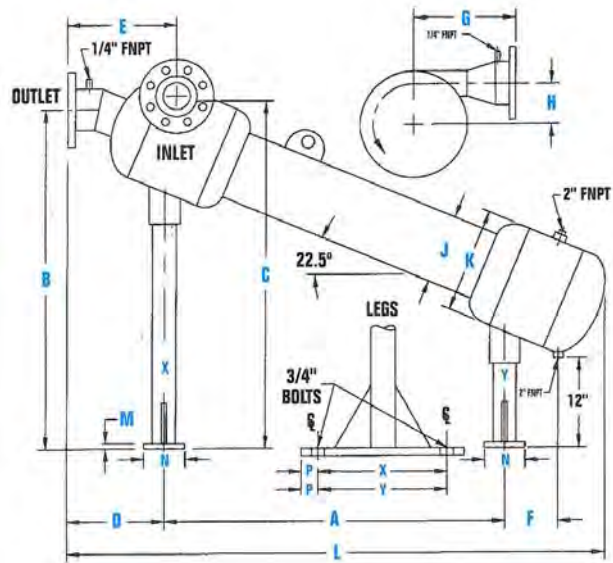

ANGLED SEPARATOR DIMENSIONS (cm)

Inlet Outlet	4"	LF6"	HF6"	8"	10"	12"	14"	16"	18"
A	123.2	160.0	160.0	180.3	198.1	259.1	260.4	274.3	301.0
B	118.1	151.1	151.1	165.1	180.3	191.3	216.9	226.8	249.7
C	118.1	153.4	149.4	167.6	184.9	194.3	220.0	228.6	254.8
D	40.6	52.1	52.1	55.4	53.3	60.5	62.2	62.0	68.6
E	48.3	52.8	52.8	57.4	62.2	67.6	70.6	73.7	85.3
F	19.1	26.7	26.7	30.5	33.0	36.3	30.5	30.5	38.1
G	48.3	55.9	55.9	62.2	73.7	81.3	85.1	85.1	87.6
H	10.2	14.7	13.5	14.2	17.8	20.6	22.9	22.9	27.9
J	16.8	27.4	27.4	32.5	40.6	45.7	50.8	61.0	71.1
K	30.5	40.6	40.6	45.7	55.9	66.0	71.1	76.2	91.4
L	203.2	269.9	269.9	289.6	313.7	353.1	387.4	406.4	449.6
M	0.6	0.6	0.6	0.6	0.6	0.6	0.6	0.6	0.6
N	12.7	12.7	12.7	12.7	12.7	12.7	15.2	15.2	15.2
P	2.5	2.5	2.5	2.5	2.5	2.5	2.5	2.5	2.5
X	55.9	76.2	76.2	86.4	106.7	127.0	127.0	137.2	146.7
Y	35.6	35.6	35.6	40.6	50.8	61.0	66.0	71.1	75.6

Angled Separator Dimensions Continued

ANGLED SEPARATOR DIMENSIONS (in)									
Inlet Outlet	4"	LF6"	HF6"	8"	10"	12"	14"	16"	18"
A	48.5	63.0	63.0	71.0	78.0	102.0	102.5	108.0	118.5
B	46.5	59.5	59.5	65.0	71.0	75.3	85.4	89.3	98.3
C	46.5"	60.4	58.8	66.0	72.8	76.5	86.6	90.0	100.3
D	16.0	20.5	20.5	21.8	21.0	23.8	24.5	24.4	27.0
E	19.0	20.8	20.8	22.6	24.5	26.6	27.8	29.0	33.6
F	7.5	10.5	10.5	12.0	13.0	14.3	12.0	12.0	15.0
G	19.0	22.0	22.0	24.5	29.0	32.0	33.5	33.5	34.5
H	4.0	5.8	5.3	5.6	7.0	8.1	9.0	9.0	11.0
J	6.6	10.8	10.8	12.8	16.0	18.0	20.0	24.0	28.0
K	12.0	16.0	16.0	18.0	22.0	26.0	28.0	30.0	36.0
L	80.0	106.3	106.3	114.0	123.5	139.0	152.5	160.0	177.0
M	0.3	0.3	0.3	0.3	0.3	0.3	0.3	0.3	0.3
N	5.0	5.0	5.0	5.0	5.0	5.0	6.0	6.0	6.0
P	1.0	1.0	1.0	1.0	1.0	1.0	1.0	1.0	1.0
X	22.0	30.0	30.0	34.0	42.0	50.0	50.0	54.0	57.8
Y	14.0	14.0	14.0	16.0	20.0	24.0	26.0	28.0	29.8

Vertical Separator Dimensions

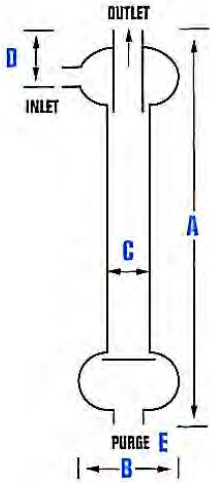

VERTICAL SEPARATOR (cm)									
Inlet Outlet	1/2"	3/4"	1"	1 1/4"	1 1/2"	2"	2 1/2"	3"	4"
A	50.8	50.8	77.5	77.5	77.5	91.4	111.8	122	132.1
B	15.2	15.2	15.2	15.2	15.2	20.3	25.4	25.4	30.5
C	6.1	6.1	8.6	8.6	8.6	11.4	11.4	14	16.8
D	5.8	5.8	5.8	5.8	5.8	7.6	8.9	8.9	17.8
E	2.5	2.5	2.5	2.5	2.5	5.1	5.1	5.1	5.1

VERTICAL SEPARATOR (in)									
Inlet Outlet	1/2"	3/4"	1"	1 1/4"	1 1/2"	2"	2 1/2"	3"	4"
A	20"	20"	30.5"	30.5"	30.5"	36"	44"	48"	52"
B	6"	6"	6"	6"	6"	8"	10"	10"	12"
C	2.4"	2.4"	3.4"	3.4"	3.4"	4.5"	4.5"	5.5"	6.6"
D	2.3"	2.3"	2.3"	2.3"	2.3"	3"	3.5"	3.5"	7"
E	1"	1"	1"	1"	1"	2"	2"	2"	2"

Flow and Pressure Drop Charts

Smaller Separators

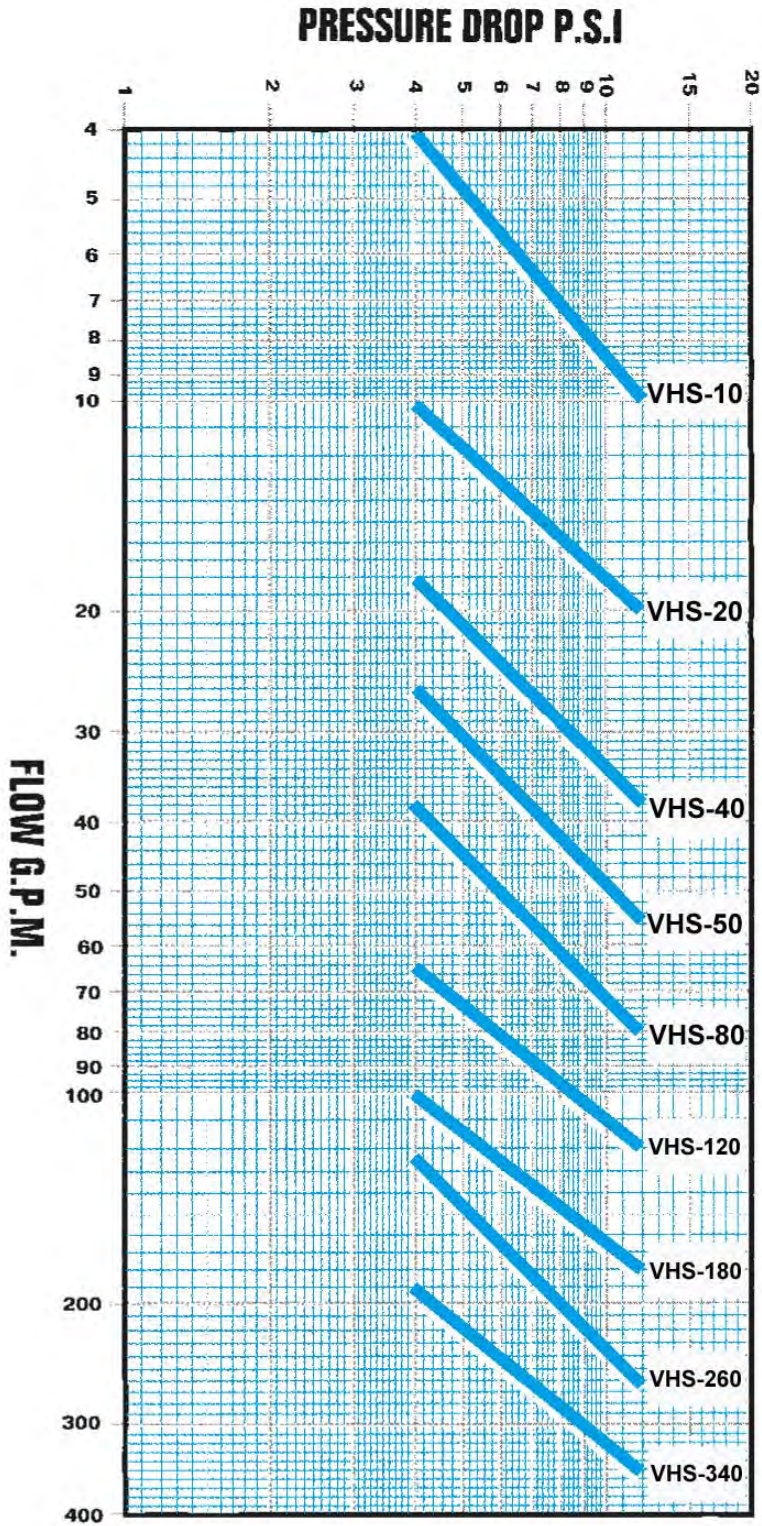

Larger Separators

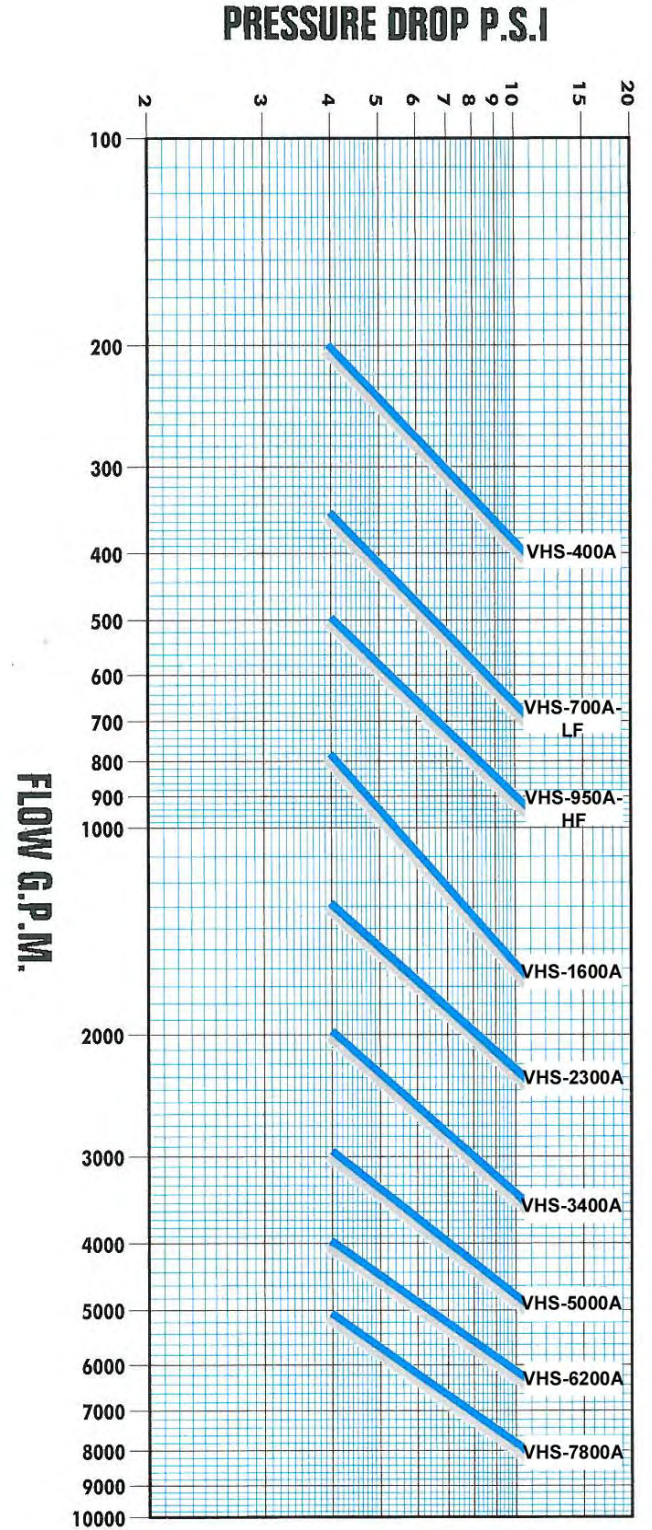

Auto-Purge Control Specifications

An automatic purge controller and valve can be used on all applications. This eliminates the need for manual flushing, turning the separator into an automatic system.

Specifications

- 115 VAC 50/60 Hz
- 3 m (10') power cord with plug
- Two-piece brass ball valve
- 1" or 2" NPT connection
- Thermoplastic top cover
- Epoxy powder coated metal base
- NEMA 4 enclosure
- Ambient temperature range:
 - 12°C (10°F) to 49°C (120°F)
- Maximum working pressure:
 - Brass: 41 bar (600 psi)
 - Stainless Steel (optional): 62 bar (900 psi)



Model PVB-LT:

- LCD cycle status display
- Demand draining capability
- External test button
- External keypad timing adjustment
- Cycle time: 1 min. to 99 hrs. 59 min.
- Open time: 1 sec. to 99 min. 59 sec.

Options and Accessories

- 12 VDC, 24 VDC, 230 VAC
- Stainless steel ball valve
- Alarm contact for remote indication of fault mode

Actuator w/standardized ISO mounting pad sold separately.

Auto-Purge Control Dimensions and Weights

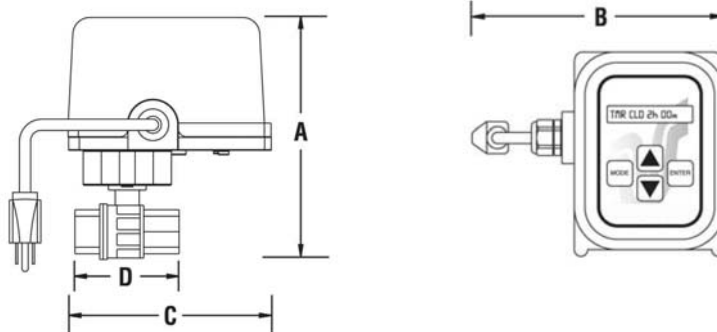

Dimensions and Weights w/Standard Brass Ball Valve

VALVE CONNECTION SIZE		A	B	C	D	APPROX. WEIGHT	
						lb	kg
1" NPT	in	8.3	6.8	6.3	4.3	11.0	5.0
	cm	21.1	17.3	16.0	10.9		
2" NPT	in	8.9	6.8	6.6	4.8	13.0	6.0
	cm	22.6	17.3	16.8	12.2		

VAF Filtration Systems

5270 Marshall Street, Arvada, CO 80002 USA

Phone +1 303 425 4242 Fax +1 303 425 0112

www.vafusa.com

sales@vafusa.com

